

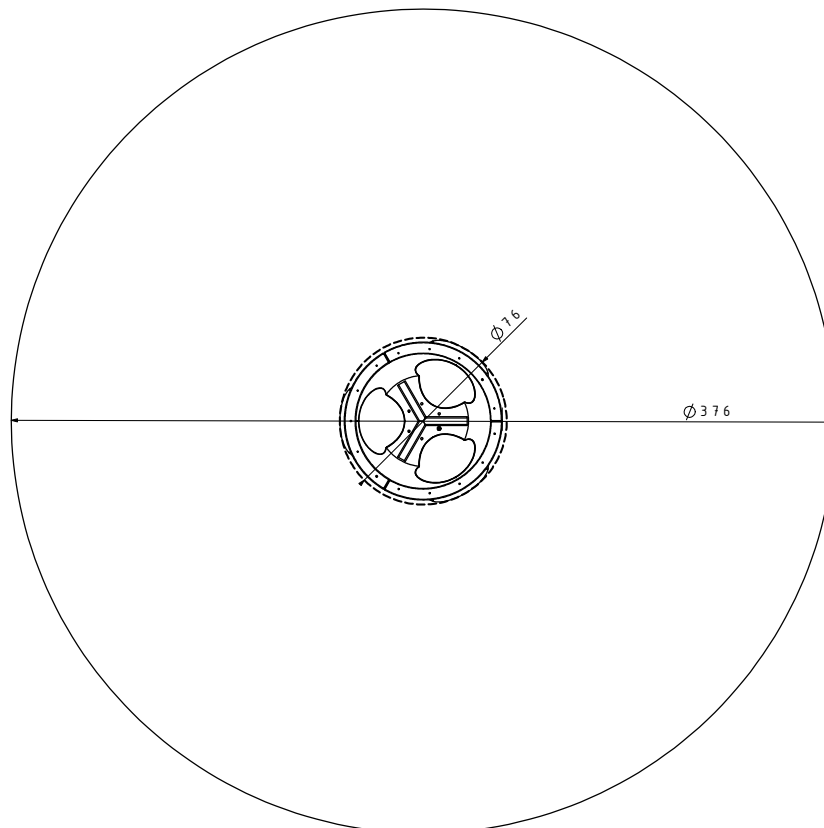

Afmetingen	76 x 76 x 217cm
Vrije ruimte	376 x 376 cm

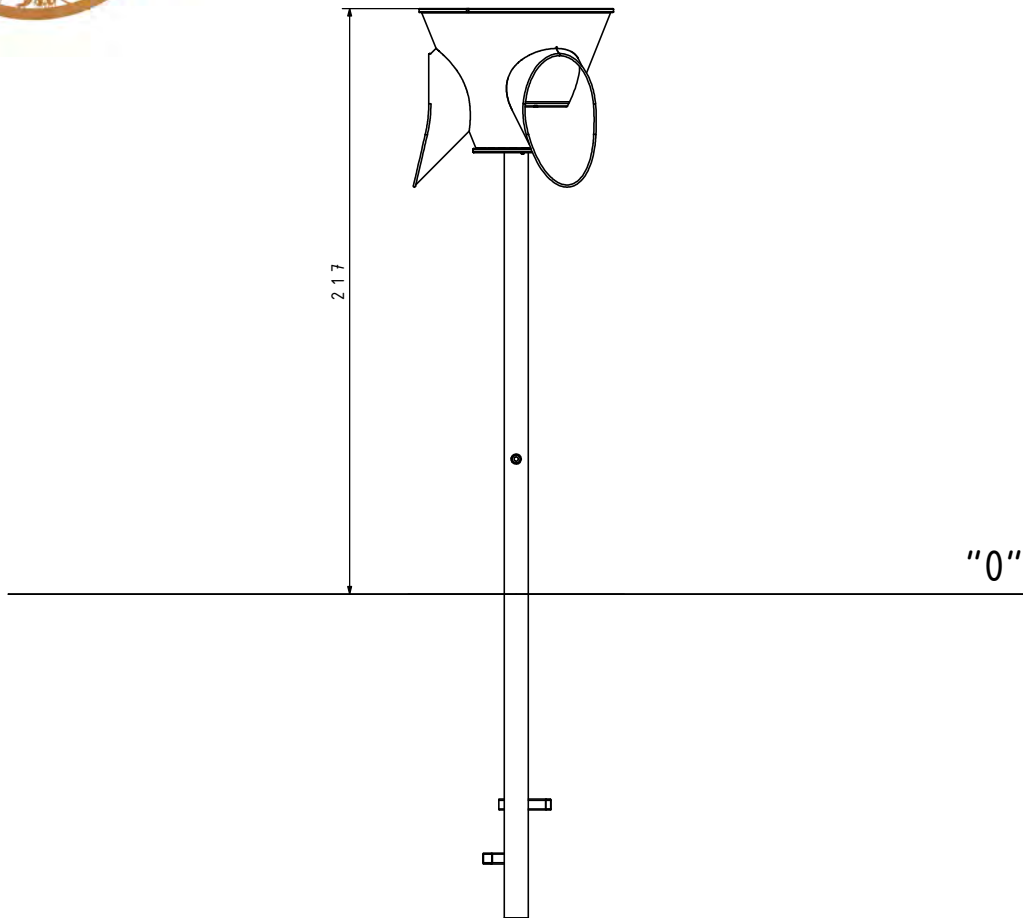

OVERZICHT



MATERIAALSPECIFICATIES

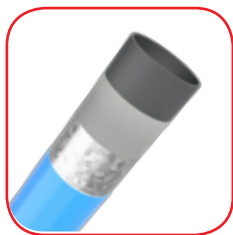

Stevige constructie gemaakt van metaal, gereinigd tijdens het zandstraalproces. De staanders worden beschermd tegen corrosie door de QUALICOAT polyester verf.



Stevige constructie gemaakt van RVS (AISI 304), bestand tegen alle weersomstandigheden.